

BAIRD Wall Mounting System

WL-2(48")

The WL-2(48") Wall Mounting System is engineered to handle up to and including a 10' (3.0M) antenna. The WL-2(48") has a 48" offset from the wall to the mast. The customer must determine if the 48" offset provides the clearances necessary for proper alignment and/or operation of their antenna. Baird Satellite offers other wall mounting systems with different offsets (23" - 36" - 60" - 60" HD).

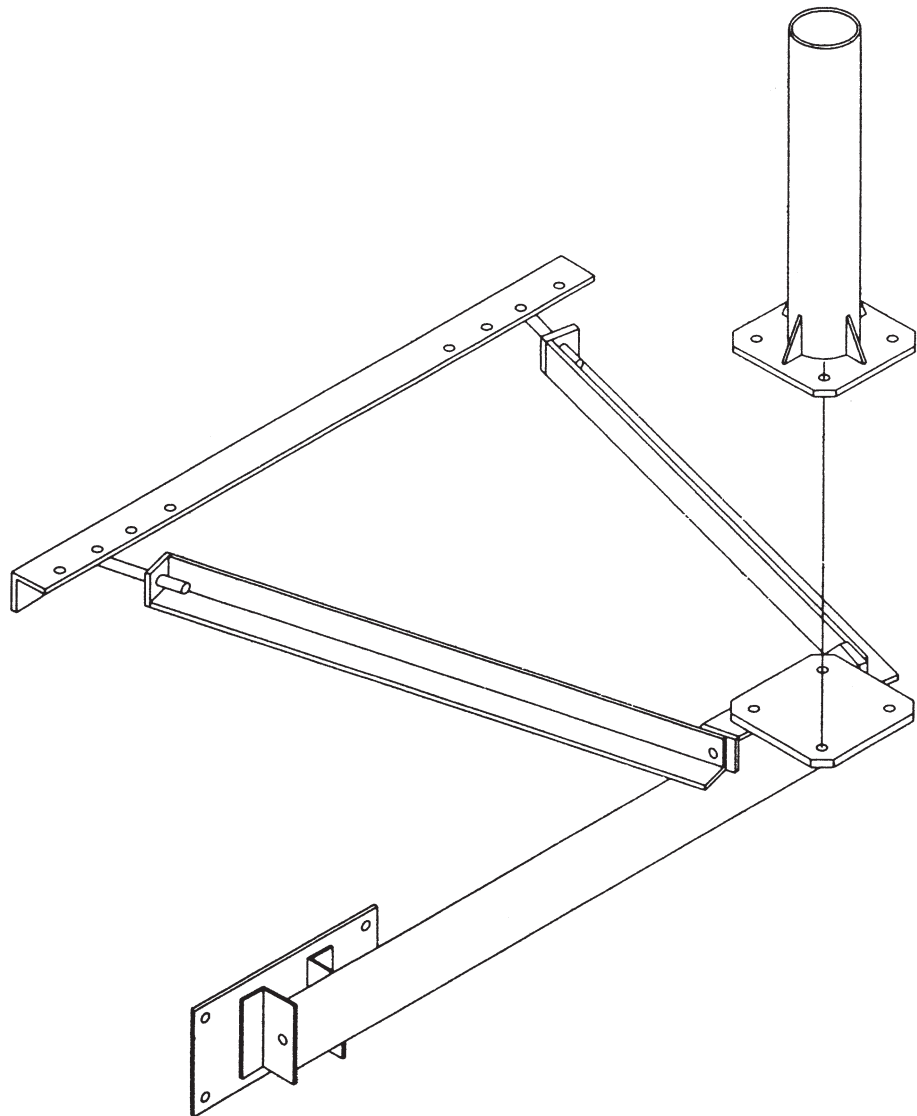

PRODUCT SPECIFICATIONS

MODEL: WL-2(48")
Wall Mounting System

TYPICAL USAGE

Wall mount system (Note: A structural engineer should review the application and determine if the wall is capable of supporting the additional loads imposed by the mounting system and antenna.

Handles up to and including a 3.0M antenna for Ku & C band - transmit and receive.

The customer must determine if the 48" offset provides the clearances necessary for proper alignment and/or operation of their antenna.

SPECIFICATIONS

The mount is made of structural steel:
Flats/Angles/Channels: A36
Tubing: A500 GR.B

All parts are hot dip galvanized after fabrication.

Hardware is zinc plated.

Masts available up to 6.62" O.D.
Typical mast length is 2' or 3'.

Mount comes with a through wall mounting kit consisting of an upper & lower back plate and 16" long threaded rod bolts.

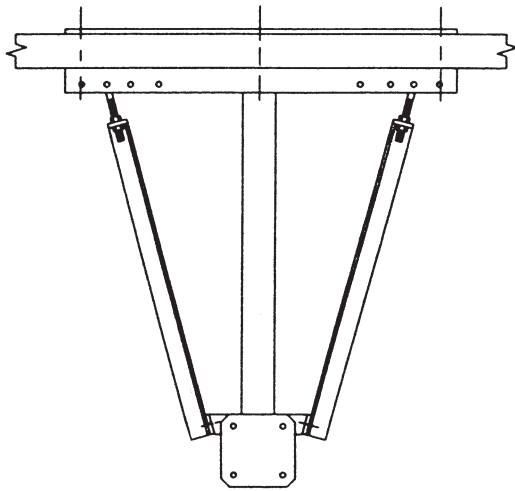

TOP VIEW

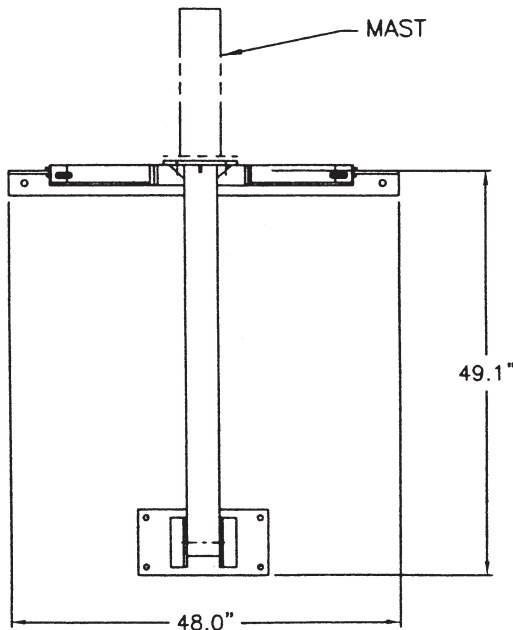

FRONT VIEW

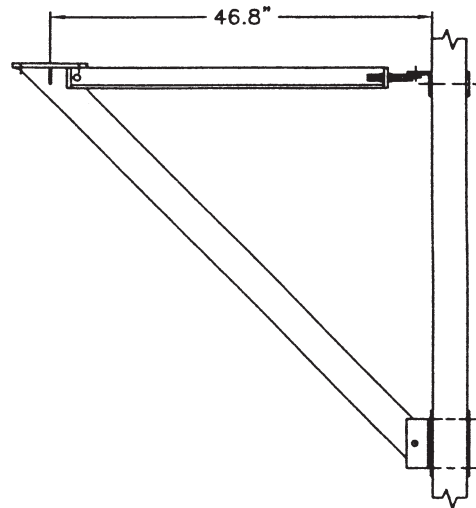

SIDE VIEW